

# Pipet-Lite™

Magnetic Assist Pipette

continuously-  
adjustable  
digital  
microliter  
pipette

11 pipettes for  
volume ranges  
from  
0.1  $\mu\text{L}$  to 20 mL

Pipet-Lite 200  $\mu\text{L}$  shown



**RAININ**

## Table of Contents

Introduction .....	1
Setting Volume.....	2
Filter .....	3
Tip Selection and Mounting .....	3
Tip Immersion Depth .....	4
Operation .....	4
Pipetting Guidelines.....	5
Pre-Rinsing Recommended .....	5
Reverse-Mode Pipetting .....	5
Pipetting Liquids of Varying Density.....	6
Temperature Considerations .....	6
Autoclaving .....	6
Tip Ejector Arm Removal .....	7
Pipet-Lite Storage .....	7
Troubleshooting and Repairs .....	8
Service, Calibration, and Repair .....	9
Specifications .....	10
Replacement Parts .....	11
Contacting RAININ.....	Back Page

## Figures

Figure 1	Pipet-Lite Pipette .....	1
Figure 2	Filter Orientation.....	3
Figure 3	Removing the Tip Ejector Arm.....	7

## Line Drawings

Pipet-Lite	2 $\mu$ L .....	12
Pipet-Lite	10 $\mu$ L .....	12
Pipet-Lite	20 $\mu$ L .....	12
Pipet-Lite	100 $\mu$ L .....	12
Pipet-Lite	200 $\mu$ L .....	12
Pipet-Lite	300 $\mu$ L .....	12
Pipet-Lite	1000 $\mu$ L .....	13
Pipet-Lite	2000 $\mu$ L .....	13
Pipet-Lite	5000 $\mu$ L .....	13
Pipet-Lite	10 mL .....	13
Pipet-Lite	20 mL .....	13

# Introduction

Pipet-Lite is an air-displacement pipette which incorporates major ergonomic improvements to reduce the risk of repetitive strain injury and pain – low force seals and lower spring forces contribute to a lighter feel. A magnet is used to help sense and hold the piston in the zero position, which reduces static force on the operator’s hand.

In the models with LTS™ shafts, the patented LifeTouch™ Tip Ejection System reduces total pipetting forces by up to 70%.

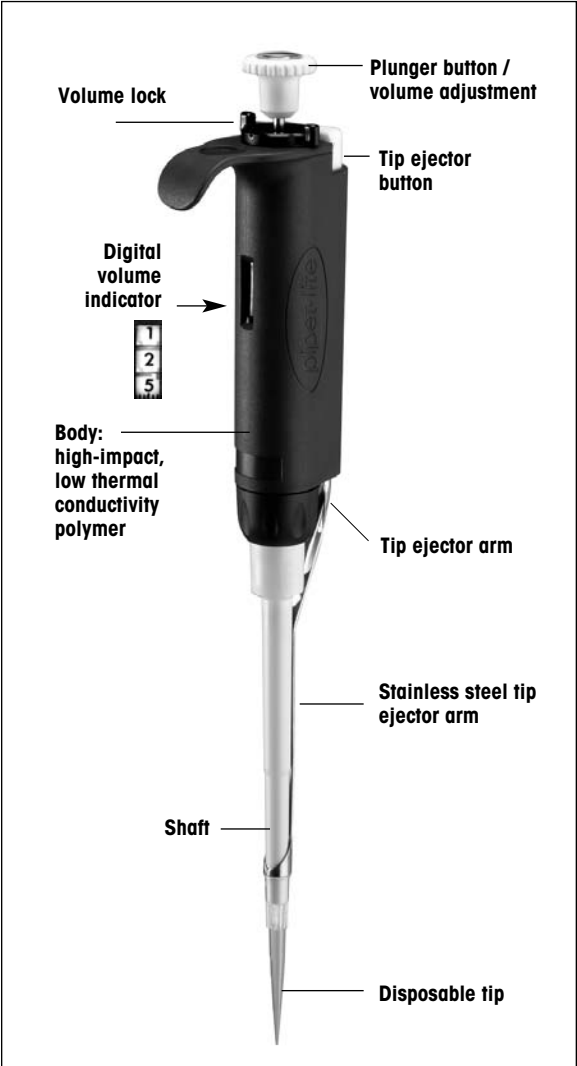
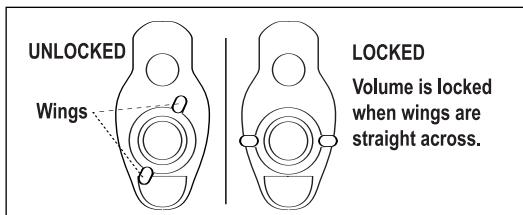

Figure 1 Pipet-Lite 200 µL

## Setting Volume

- Turn the volume lock counter-clockwise to the position shown at left below so the volume setting mechanism is unlocked and free to turn.



- With the mechanism unlocked, orient Pipet-Lite so you are looking at the digital volume indicator, then rotate the plunger button to change volume – counter-clockwise to increase, and clockwise to decrease volume.

The volume indicator is read from the top down.

2 $\mu$ l	10 $\mu$ l	20 $\mu$ l	100 $\mu$ l	200 $\mu$ l	300 $\mu$ l	1000 $\mu$ l	2000 $\mu$ l	5000 $\mu$ l	10 ml	20 ml
1 2 5	0 7 5	1 2 5	0 7 5	1 2 5	2 2 5	0 7 5	1 2 5	4 2 5	0 7 5	1 2 5
1.25 $\mu$ l	7.5 $\mu$ l	12.5 $\mu$ l	75 $\mu$ l	125 $\mu$ l	225 $\mu$ l	0.75 ml	1.25 ml	4.25 ml	7.5 ml	12.5 ml
Red digits						Black digits				

2–20  $\mu$ L: Black –  $\mu$ L. Red – tenths, hundredths of  $\mu$ L.

100–300  $\mu$ L: All digits black – whole  $\mu$ L.

1000–5000  $\mu$ L: Red – mL. Black – tenths, hundredths of mL.

10 mL: Red – mL. Black – tenths of mL

20 mL: Red – mL. Black – tenths of mL.

- To eliminate errors due to mechanical backlash: when setting the desired volume, first turn the knob  $\frac{1}{3}$  turn above the desired volume. Then turn the knob slowly clockwise until the desired volume is displayed. **Always dial down to the desired volume.**
- Turn the volume lock clockwise (see diagram above) to prevent accidental changes to the volume setting.

Example volumes for the 200  $\mu$ L model are shown below (note the intermediate setting at the right).

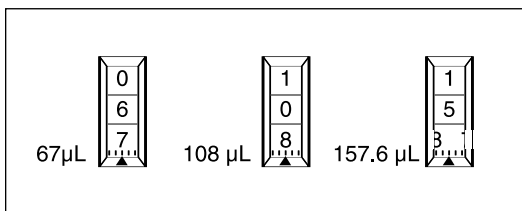

Volume ranges and increments are shown below:

Pipet-Lite Volume	Range ( $\mu\text{L}$ )		Increment $\mu\text{L}$
	Adjustable	Recommended	
2 $\mu\text{L}$	0 to 2	0.1 to 2	0.002
10 $\mu\text{L}$	0 to 10	0.5 to 10	0.02
20 $\mu\text{L}$	0 to 20	2 to 20	0.02
100 $\mu\text{L}$	0 to 100	10 to 100	0.2
200 $\mu\text{L}$	0 to 200	20 to 200	0.2
300 $\mu\text{L}$	0 to 300	30 to 300	0.5
1000 $\mu\text{L}$	0 to 1,000	100 to 1,000	2.0
2000 $\mu\text{L}$	0 to 2,000	200 to 2,000	2.0
5000 $\mu\text{L}$	0 to 5,000	500 to 5,000	5.0
10 mL	0 to 10 mL	1 mL to 10 mL	20.0
20 mL	0 to 20 mL	2 mL to 20 mL	20.0

## Filter

Pipet-Lite 5000  $\mu\text{L}$ , 10 mL, and 20 mL pipettes use a filter in the end of the shaft to help prevent liquid entering the shaft and contaminating the piston, should the plunger snap up during aspiration. Using such a filter is particularly important when pipetting large volumes. Replace the filter if it gets wet.

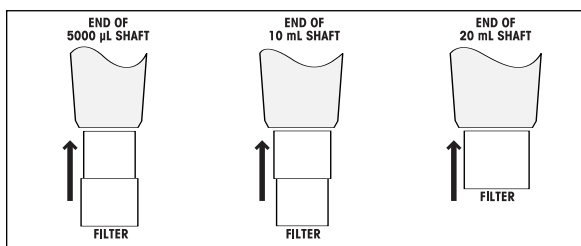

**Figure 2 Filter Orientation**

The 5000  $\mu\text{L}$  and 10 mL pipettes use the same filter oriented as shown in the diagram above:

5000  $\mu\text{L}$ : insert the small diameter into the shaft.

10 mL: insert the large diameter into the shaft.

Filter part numbers are 6190-164 (pack of 100) and 6190-165 (pack of 1000).

The filter for 20 mL is a cylinder. Filter part numbers: 6190-221 (pack of 100) and 6190-222 (pack of 500).

## Tip Selection and Mounting

Always use RAININ tips with Pipet-Lite pipettes. Pipet-Lite pipettes are calibrated with RAININ tips, and performance to published specifications can only be guaranteed when RAININ tips are used.

To mount a tip, press the Pipet-Lite shaft into the end of the tip with light force. The tip will seal properly on the shaft with minimal force — do not use more force than is required.

## Tip Immersion Depth

---

The recommended depth for tip insertion into the sample for each Pipet-Lite volume is shown below.

Pipet-Lite	Volume Range	Immersion Depth
2 $\mu$ L	0.1 - 2 $\mu$ L	1-2 mm
10 $\mu$ L	0.5 - 10 $\mu$ L	1-2 mm
20 $\mu$ L	2 - 20 $\mu$ L	2 - 3 mm
100 $\mu$ L	10 - 100 $\mu$ L	2 - 3 mm
200 $\mu$ L	20 - 200 $\mu$ L	3 - 6 mm
300 $\mu$ L	30 - 300 $\mu$ L	3 - 6 mm
1000 $\mu$ L	100 - 1000 $\mu$ L	3 - 6 mm
2000 $\mu$ L	200 - 2000 $\mu$ L	3 - 6 mm
5000 $\mu$ L	500 - 5000 $\mu$ L	6 - 10 mm
10 mL	1 mL - 10 mL	6 - 10 mm
20 mL	2 mL - 20 mL	6 - 10 mm

Tip immersion depth is critical. If these depths are exceeded, the volume measured may be inaccurate, possibly out of specification. Tip angle is also important. Hold the pipette within 20 degrees of vertical.

## Operation

---

Before pipetting valuable samples, it is a good idea to practice aspirating and dispensing water before pipetting with actual samples.

1. Set the desired volume as described on page 2.
2. Attach a new RAININ tip. Press the shaft into the tip with only sufficient force to make a good seal.
3. Press the plunger button to the FIRST STOP, and hold it in this position. The magnetic latch will help you sense and hold this position.
4. Holding Pipet-Lite vertically, place the tip into the sample to the proper depth and relax your thumb pressure on the plunger. The light piston spring will move the piston upward, aspirating sample. Do not let go of the plunger button, or the piston may snap up quickly, resulting in inaccurate measurement.
5. Pause briefly (longer for macrovolume pipettes) to ensure that the full volume of sample is drawn into the tip.
6. Withdraw the tip from the sample. If any liquid remains on the outside of the tip, wipe it carefully with a lint-free tissue, taking care not to touch the tip orifice.

## **Dispensing:**

1. Touch the tip end against the side wall of the receiving vessel and press the plunger slowly, past the FIRST STOP, to blowout (bottom of stroke.) Wait: 1 second for 2–300  $\mu\text{L}$  volumes, 1-2 seconds for 1000  $\mu\text{L}$  and larger. (Longer for viscous solutions.)
2. Still holding the plunger, withdraw the tip, sliding it along the wall of the vessel. Release the plunger.
3. Press the tip ejector button lightly to discard the tip. Use a new tip for each sample to prevent carry-over. Repeat for the next pipetting cycle.

## **Pipetting Guidelines**

---

Pipet-Lite pipettes incorporate several new features which enhance pipetting consistency. You should also maintain:

1. Consistent pickup and dispense rhythm.
2. Consistent speed and smoothness when pipetting.
3. Consistent pressure on the plunger button at the FIRST STOP.
4. Consistent immersion depth. See table on page 4.
5. Pipette vertically, or within  $20^\circ$  of vertical.
6. Don't invert or lay the pipette flat with liquid in the tip.

## **Pre-Rinsing Recommended**

---

Some solutions may leave a film on the inside tip wall. This film remains relatively constant in successive pipettings with the same tip, so excellent precision can be obtained by re-filling the tip and using the refilled volume as the sample. Successive samples from this same tip will exhibit good reproducibility.

## **Reverse Mode Pipetting**

---

Another way of reducing error due to film retention, especially useful for more viscous liquids, is reverse mode pipetting. The operating sequence is reversed:

1. Mount a disposable tip on the pipette shaft.
2. Press the pushbutton fully to the SECOND STOP.
3. Immerse the tip in liquid and allow the button to return slowly to the fully UP position. Wait a moment for the liquid column to reach equilibrium in the tip.

4. Wipe any excess liquid from the outside of the tip without touching the orifice.
5. To dispense, rest the end of the tip against the vessel wall and press the plunger to the first stop. Hold this position a few seconds, or long enough for the liquid column to reach equilibrium again.
6. Remove the tip from the receiving vessel without blowing out the remaining liquid.
7. Return excess sample in the tip to the original sample container, if desired. Discard the used tip.

## **Pipetting Liquids of Varying Density**

Pipet-Lite lets you compensate for solutions of density much different from water, by setting the volume slightly higher or lower than that required. The compensation amount must be determined empirically.

For example, if pipetting 10  $\mu\text{L}$  of CsCl solution, you determine that the volume delivered is actually 8.5  $\mu\text{L}$  ( $\geq 5$  samples). Change the volume setting to 11.8  $\mu\text{L}$  and repeat the measurements. If the volumes delivered are still not close enough to 10  $\mu\text{L}$ , make another slight volume adjustment until the measurements are as desired.

## **Temperature Considerations**

Warm or cold liquids can be measured with good precision by using a consistent pipetting rhythm. This will help minimize any differences in heating or cooling effects within the pipette.

Use a new tip each time for best accuracy and precision when measuring samples with temperatures greatly different from ambient, and do not pre-rinse. As with any air-displacement pipette, you will get best results if there is no delay between picking up the sample and dispensing it.

## **Autoclaving**

Autoclavable parts of Pipet-Lite are the shaft and the tip ejector: 121°C, 1 bar, 15-20 minutes.

**Do not autoclave the complete pipette or any parts other than the shaft and the tip ejector.**

## Tip Ejector Arm Removal

Three types of tip ejector are used and all types can be removed with minimum effort - **do not use force**.

**For models up to 2000  $\mu\text{L}$** , press in the quick-release tabs on the ejector arm and pull the ejector down.

**For 5000  $\mu\text{L}$  and 10 mL models**, grasp the top of the ejector arm and pull outward then downward.

**For the 20 mL model**, pull off the lower part of the ejector arm; the upper part stays in place. (Replace by aligning the rod with the hole in the upper part and pressing firmly.)

To replace the ejector arm (except 20 mL), insert the shaft through the large opening, align the top with the tip ejector pushrod, and push until the ejector arm snaps in place.

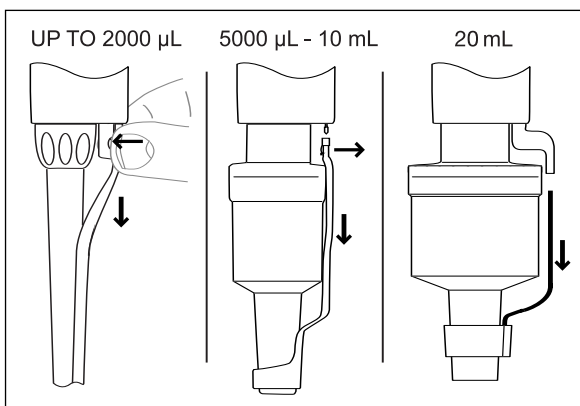

**Figure 3 Removing the Tip Ejector Arm**

## Pipet-Lite Storage

After use, store the pipette in a clean safe place. Pipet-Lite is a precision instrument and should be treated with the level of care appropriate for laboratory instrumentation. Three types of hanger are available to hold your Pipet-Lite conveniently when not in use.

**CR-7:** Free-standing carousel holds seven pipettes.

**HU-M3:** Set of three individual magnetic Hang-Ups™ for mounting on ferrous surfaces.

**HU-S3:** Three Hang-Ups attached to a clamp which fits onto a shelf.

## Troubleshooting and Repairs

---

### **WARNING:**

**When removing the shaft from the pipette body, make sure the spring, seal and o-ring do not fall off the piston, especially on the smaller models.**

### **Sample Splash (liquid inside the mechanism)**

1. Remove the tip ejector arm. Also refer to the appropriate drawing on page 12 or 13.
2. On pipettes up to 1000  $\mu\text{L}$ , unscrew the shaft coupling (B) and remove the shaft (C). For 2000  $\mu\text{L}$ , unscrew the shaft. For 5000  $\mu\text{L}$ , 10 mL and 20 mL unscrew the lower part of the shaft. Note the way the spring, seal and O-ring fit on the piston.
3. Inspect the seal assembly and piston for contamination. The piston should be shiny and free of corrosion. Clean with distilled water or isopropyl alcohol. Dry with a lint-free tissue and reassemble after inspecting the interior of the shaft for any contamination. For 5000  $\mu\text{L}$ , 10 mL and 20 mL models, apply a small amount of grease to the seal.
4. If piston corrosion or staining is evident, do not use the instrument. Call 800-662-7027 for Service.

### **Leaks, Inaccuracy, Abnormal Stroke**

1. **Loose shaft.** Tighten coupling by hand.
2. **Split or cracked shaft.** Remove the tip ejector and inspect the shaft. Replace the shaft if necessary. If the shaft was dropped, remove it to see if the piston is bent. If so, return the instrument for service.
3. **Worn seal and / or o-ring.** All models up to 2000  $\mu\text{L}$  incorporate a polyethylene seal and o-ring. Examine the seal and o-ring, replacing them as necessary. Pull off the old seal and o-ring, position the new seal and o-ring on the piston assembly as shown in the drawings on pages 12-13, and reassemble the pipette.

**Note: It is NOT necessary to recalibrate Pipet-Lite after changing seals.**

4. **Do not lubricate any components\*.** Pipet-Lite uses a dry sealing system. \*Except 5000 $\mu\text{L}$ , 10 mL, and L-20ML models. These pipettes require a small amount of grease to be applied to the o-ring to make the seal.

## Acids and Corrosives

After pipetting concentrated acids or highly corrosive solutions, disassemble Pipet-Lite and inspect and clean the piston assembly, shaft, and seal with distilled water. Dry all components thoroughly and reassemble.

Extensive contact with corrosive fumes may result in premature seal wear and damage to the piston. Exposure of internal components to corrosive fumes can be reduced by using RAININ tips with aerosol barrier filters.

## Service, Calibration and Repair

---

**RAININ** Pipette Repair and Calibration facilities:

**California:** 7500 Edgewater Drive, Oakland CA 94621

Tel. 800-662-7027, Fax 510-564-1683

**Massachusetts:** Rainin Road, Woburn, MA 01801

Tel. 800-662-7027, Fax 781-935-7631

**Japan:** 4-1-11, Bunkyo-Ku, Tokyo 113-0033

Tel. (03) 5689-8311, Fax (03) 5689-2670

**METTLER TOLEDO** Pipette Repair and Calibration facilities:

**Belgium:** N.V. Mettler-Toledo s.a., B-1932 Zaventem

Tel. (02) 334 02 11, Fax (02) 334 03 34

**Germany:** Mettler-Toledo GmbH, D-35353 Giessen

Tel. (0641) 50 70, Fax (0641) 507 128

**Denmark:** Mettler-Toledo A/S, DK-2600 Glostrup

Tel. (43) 270 800, Fax (43) 270 828

**Spain:** Mettler-Toledo S.A.E., E-08038 Barcelona

Tel. (93) 223 76 00, Fax (93) 223 02 71

**France:** HTS – F28000 Chartres

Tel. (02) 37 88 31 00, Fax (02) 37 88 31 09

**Italy:** Mettler-Toledo S.p.A., I-20026 Novate Milanese

Tel. (02) 333 321, Fax (02) 356 29 73

**Netherlands:** Mettler-Toledo B.V., NL-4004 JK Tiel

Tel. (0344) 638 363, Fax (0344) 638 390

**Sweden:** Mettler-Toledo AB, S-12008 Stockholm

Tel. (08) 702 50 00, Fax (08) 642 45 62

Service is also available in many other countries through authorized RAININ distributors. See [www.rainin-global.com](http://www.rainin-global.com).

Note: It is recommended to use only genuine RAININ replacement parts such as seals and shafts. It is NOT necessary to recalibrate the pipette after changing the seal or shaft. Recalibration of the pipette is only necessary when the piston is replaced, and should be done only by qualified factory-trained personnel in one of the above-mentioned facilities.

## Specifications

These manufacturer's specifications should be used as guidelines when establishing your own performance specification.

Pipet-Lite Specifications						
Model	Volume $\mu\text{L}$	Increment $\mu\text{L}$	Accuracy		Precision	
			%	$\mu\text{L} (\pm)$	%	$\mu\text{L} (\leq)$
2 $\mu\text{L}$	0.2	0.002	12.0	0.024	6.0	0.012
	1.0		2.7	0.027	1.3	0.013
	2.0		1.5	0.030	0.7	0.014
10 $\mu\text{L}$	1.0	0.02	2.5	0.025	1.2	0.012
	5.0		1.5	0.075	0.6	0.03
	10.0		1.0	0.1	0.4	0.04
20 $\mu\text{L}$	2	0.02	7.5	0.15	2.0	0.04
	10		1.5	0.15	0.5	0.05
	20		1.0	0.2	0.3	0.06
100 $\mu\text{L}$	10	0.2	3.5	0.35	1.0	0.1
	50		0.8	0.4	0.24	0.12
	100		0.8	0.8	0.15	0.15
200 $\mu\text{L}$	20	0.2	2.5	0.5	1.0	0.2
	100		0.8	0.8	0.25	0.25
	200		0.8	1.6	0.15	0.3
300 $\mu\text{L}$	30	0.5	2.5	0.75	1.0	0.3
	150		0.8	1.2	0.25	0.375
	300		0.8	2.4	0.15	0.45
1000 $\mu\text{L}$	100	2	3.0	3.0	0.6	0.6
	500		0.8	4.0	0.2	1.0
	1000		0.8	8.0	0.15	1.5
2000 $\mu\text{L}$	200	2	3.0	6.0	0.6	1.2
	1000		0.8	8.0	0.2	2.0
	2000		0.8	16.0	0.12	2.4
5000 $\mu\text{L}$	500	5	2.4	12.0	0.6	3.0
	2500		0.6	15.0	0.2	5.0
	5000		0.6	30.0	0.16	8.0
10 mL	1 mL	20	5.0	50.0	0.6	6.0
	5 mL		1.0	50.0	0.2	10.0
	10 mL		0.6	60.0	0.16	16.0
20 mL	2 mL	20	5.0	100.0	0.6	12.0
	10 mL		1.0	100.0	0.2	20.0
	20 mL		0.6	120.0	0.16	32.0

Specifications are subject to change without notice.

# Replacement Parts (see pages 12-13)

## Legend for Pipet-Lite 2 µL to 2000 µL

<b>A - Plunger Button</b>	<b>B- Shaft Coupling</b>	<b>C - Shaft*</b>
<b>D - Tip Ejector*</b>	<b>E - Piston Assembly</b>	<b>F - Seal</b>
<b>G - O-ring</b>	<b>H - Stroke Spring</b>	<b>J - Seal Retainer</b>

### L- Series:

	<b>L-2</b>	<b>L-10</b>	<b>L-20</b>	<b>L-100</b>	<b>L-200</b>	<b>L-300</b>	<b>L-1000</b>	<b>L-2000</b>
A	6202-055	6202-056	6202-057	6202-058	6202-059	6202-306	6202-060	6202-192
B	6202-062	6202-062	6202-062	6202-062	6202-062	6202-062	6202-062	n/a
C	6202-063	6202-064	6202-065	6202-066	6202-067	6202-425	6202-068	6202-214
D	6202-071	6202-071	6202-071	6202-073	6202-073	6200-419	6202-074	6200-168
E	6202-076	6202-077	6202-078	6202-079	6202-080	6202-427	6202-081	6202-082
F	6200-131	6200-138	6200-143	6200-150	6200-154	6200-415	6200-161	6200-166
G	6200-132	6200-139	6200-170	6200-151	6200-155	6200-414	6200-162	6200-167
H	6202-083	6202-083	6202-083	6202-084	6202-084	6202-084	n/a	n/a
J	6200-196	6200-196	6200-198	6200-201	6200-200	6200-416	n/a	n/a

### SL- Series:

	<b>SL-2</b>	<b>SL-10</b>	<b>SL-20</b>	<b>SL-100</b>	<b>SL-200</b>	<b>SL-300</b>	<b>SL-1000</b>	<b>SL-2000</b>
A	6202-109	6202-110	6202-111	6202-112	6202-113	6202-426	6202-114	6202-115
B	6202-062	6202-062	6202-062	6202-062	6202-062	6202-062	6202-062	n/a
C	6200-134	6200-140	6200-145	6200-147	6200-157	6200-413	6200-160	6200-169
D	6200-133	6200-133	6200-144	6200-148	6200-156	6200-419	6200-163	6200-168
E	6202-183	6202-184	6202-185	6202-079	6202-080	6202-427	6202-081	6202-082
F	6200-131	6200-138	6200-143	6200-150	6200-154	6200-415	6200-161	6200-166
G	6200-132	6200-139	6200-170	6200-151	6200-155	6200-414	6200-162	6200-167
H	6202-083	6202-083	6202-083	6202-084	6202-084	6202-084	n/a	n/a
J	6200-196	6200-196	6200-198	6200-201	6200-200	6200-416	n/a	n/a

\* These parts are autoclavable (C - shaft, D - tip ejector arm)

## Legend for Pipet-Lite 5000 µL , 10 mL and 20 mL

<b>A - Plunger Button</b>	<b>C- Tip Ejector*</b>	<b>D - Piston Assembly</b>
<b>E - Piston O-ring</b>	<b>F - Cylinder</b>	<b>G - Cylinder O-ring</b>
	<b>H - Shaft*</b>	

### L- Series:

#### L-5000

#### L-10ML

#### L-20ML

### SL- Series:

#### SL-5000

#### SL-10ML

<b>A</b>	6202-193	6202-194	6202-297	6202-217	6202-218
<b>C</b>	6200-373	6200-374	6202-298	6200-373	6200-374
<b>D</b>	6202-215	6202-216	6202-296	6202-215	6202-216
<b>E</b>	6200-363	6200-369	6202-299	6200-363	6200-369
<b>F</b>	6200-365	6200-371	6202-301	6200-365	6200-371
<b>G</b>	6200-364	6200-370	6202-300	6200-364	6200-370
<b>H</b>	6202-222	6202-223	6202-302	6200-362	6200-368

\* These parts are autoclavable (C - tip ejector arm, H - shaft)

### Common parts for 5000 µL, 10 mL, and 20 mL:

Tube of grease:	6100-555
Filters for 5000 µL and 10 mL:	6190-164 (pack of 100)
	6190-165 (pack of 1000)
for 20 mL:	6190-221 (pack of 100)
	6190-222 (pack of 500)

### Pipet-Lite 2 & 10 $\mu\text{L}$

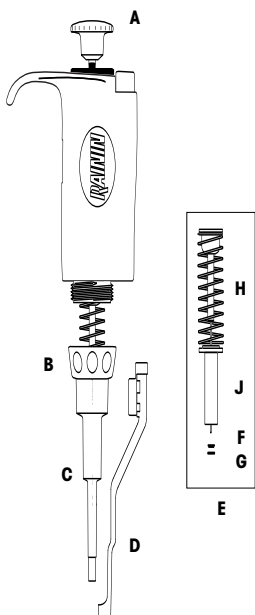

### Pipet-Lite 20 $\mu\text{L}$

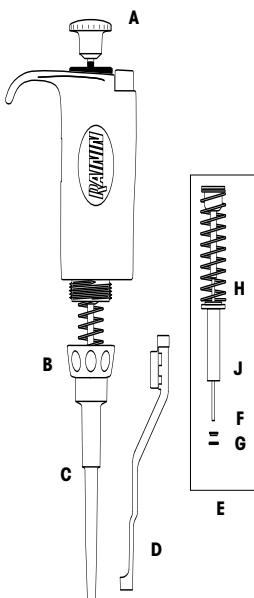

### Pipet-Lite 100 $\mu\text{L}$

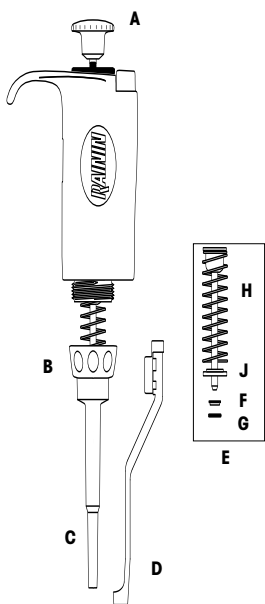

### Pipet-Lite 200 & 300 $\mu\text{L}$

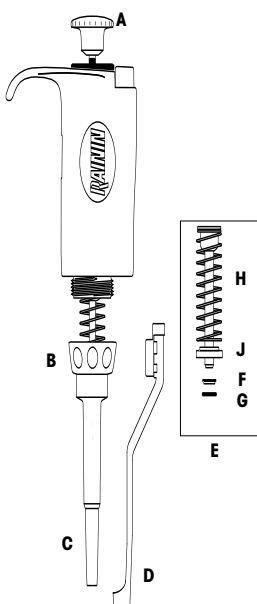

**Legend for Pipet-Lite 2  $\mu\text{L}$  to 2000  $\mu\text{L}$  Models  
(this page and top of next page)**

**A - Plunger Button**

**B - Shaft Coupling**

**C - Shaft**

**D - Tip Ejector**

**E - Piston Assembly**

**F - Seal**

**G - O-ring**

**H - Stroke Spring**

**J - Seal Retainer**

### Pipet-Lite 1000 $\mu$ L

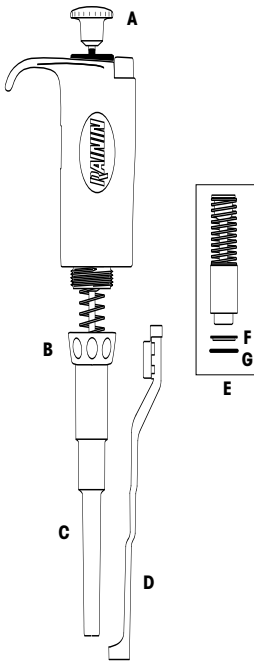

### Pipet-Lite 2000 $\mu$ L

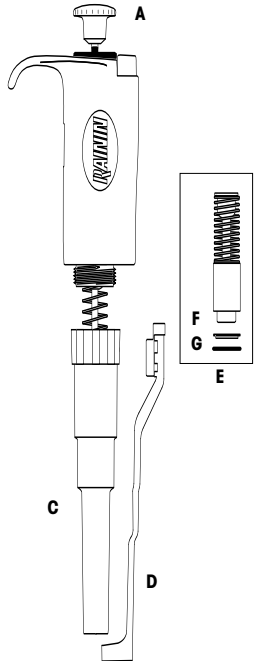

### Legend for Pipet-Lite 5000 $\mu$ L, 10 mL and 20 mL (below)

A - Plunger Button  
E - Piston O-ring  
H - Shaft

C - Tip Ejector Arm  
F - Cylinder

D - Piston Assembly  
G - Cylinder O-ring

### Pipet-Lite 5000 $\mu$ L & 10 mL

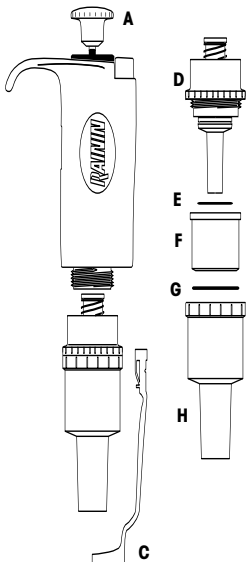

### Pipet-Lite 20 mL

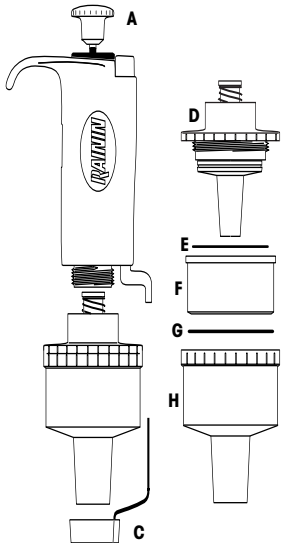

### Limited Warranty

See the enclosed Limited Warranty and Limitations of Liability Statement. Please complete and return the Warranty Registration Card on receipt of your pipette.

RAININ pipettes are calibrated with RAININ tips. To assure excellent reproducibility and performance, use only RAININ tips as recommended in this manual. Specified performance is guaranteed only when RAININ tips are used.

## Contacting RAININ

---

### Technical Information:

Phone: 800-543-4030  
Fax: 781-938-1152  
E-mail: tech.support@rainin.com

### Pipette Service:

Phone: 800-662-7027  
Fax: 781-935-7631  
E-mail: service@rainin.com

### Direct Order Line:

Phone: 800-472-4646  
Fax: 781-938-1152  
E-mail: pipets@rainin.com

**Web:** [www.rainin.com](http://www.rainin.com)

---

### From outside the U.S.:

Phone: +1-510-564-1600

### RAININ Japan:

Phone: + 81 3 5689-8311  
Fax: + 81 3 5689-2670

### METTLER TOLEDO GmbH, Switzerland

Phone: +41 1 944 45 45  
Fax: +41 1 944 45 10

Other International Offices and Distributors:

See [www.rainin-global.com](http://www.rainin-global.com)

**E-mail:** [global@rainin.com](mailto:global@rainin.com) (from outside the U.S.)

**Web:** [www.rainin-global.com](http://www.rainin-global.com) (from outside the U.S.)

---

# RAININ

Rainin Instrument, LLC

7500 Edgewater Drive, Box 2160, Oakland, CA 94621-0060

a METTLER TOLEDO Company

Prices and specifications are subject to change without notice.

Copyright 2005, Rainin Instrument, LLC.

