

Fine structure of the characteristic x-radiation of a molybdenum anode

Objects of the experiment

- Investigating the fine structure of the characteristic x-radiation of molybdenum by means of Bragg reflection at an NaCl monocrystal in the fifth diffraction order.
- Identifying the characteristic K_{α} , K_{β} and K_{γ} lines.
- Resolving the fine structure of the K_{α} line as a line doublet and determining the wavelength interval $\Delta\lambda$ within the doublet.

Principles

On closer examination, the characteristic K_{α} and K_{β} lines of the x-radiation prove to be line doublets. The two doublets can be resolved by means of Bragg reflection at an NaCl monocrystal when measured in a higher diffraction order. However, they differ in their physical nature.

The K_{β} doublet consists of the pure K_{β} line, i.e. transitions of excited atoms from the M-shell to the K-shell, and the K_{γ} line, i.e. transitions from the N-shell to the K-shell. The wavelength interval $\Delta\lambda$ between the two lines is just 1.2 pm (see table 1), so that they can only be resolved at a high resolution.

Table 1: Transition energies E , wavelengths λ and relative components of the characteristic K_{α} , K_{β} and K_{γ} lines of molybdenum (weighted mean values according to [1])

	$\frac{E}{\text{keV}}$	$\frac{\lambda}{\text{pm}}$	Relative proportion
K_{α}	17.44	71.08	1.000
K_{β}	19.60	63.26	0.170
K_{γ}	19.97	62.09	0.027
Doublet $K_{\beta} + K_{\gamma}$	19.65	63.09	

The fine structure of the K_{α} line arises from the fine structure of the L-shell, and thus ultimately from the spin-orbit characteristic of the electrons. The L-shell actually consists of three sub-shells, designated L_I , L_{II} and L_{III} in x-ray spectroscopy. The transitions from these sub-shells to the K-shell with emission of an x-ray is subject to the selection rules

$$\Delta l = \pm 1, \Delta j = 0, \pm 1 \quad (I)$$

for the change of the orbital angular momentum l and the total angular momentum j on transition. Thus, two transitions from the L-shell to the K-shell are permitted, designated $K_{\alpha 1}$ and $K_{\alpha 2}$ (see Fig. 1). Table 2 shows the values generally found in the literature for molybdenum. According to these, the wavelength interval within the K_{α} doublet is $\Delta\lambda = 0.43$ pm.

Table 2: Wavelengths λ (calculated from literature specifications [1] for transition energies) and relative proportions of K_{α} radiation of molybdenum

Line	$\frac{\lambda}{\text{pm}}$	Relative proportion
$K_{\alpha 1}$	70.93	1.000
$K_{\alpha 2}$	71.36	0.525

Fig. 1 Diagram of fine structure of the characteristic line K_{α}

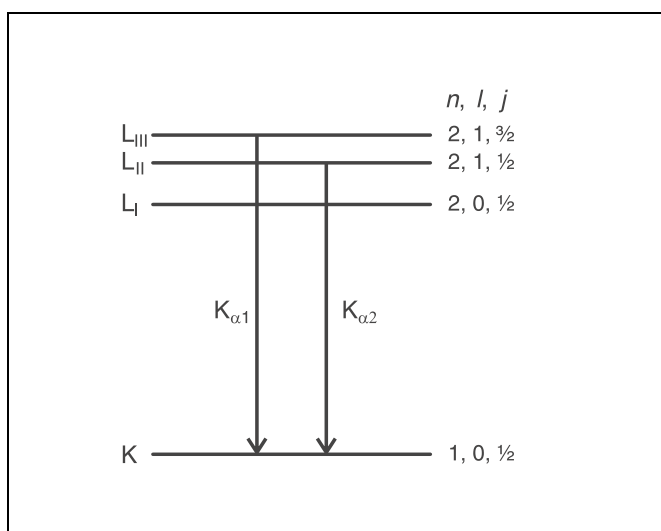

Apparatus

- 1 X-ray apparatus 554 811
- 1 End-window counter
for α , β , γ and x-ray radiation 559 01
- additionally required:
- 1 PC with Windows 9x/NT

The object of the experiment is to resolve this fine structure by means of Bragg reflection at an NaCl monocrystal at higher diffraction orders.

According to Bragg's law of reflection, the following relationship exists between the wavelength λ of the incident characteristic radiation and the glancing angle ϑ at which we may expect an intensity maximum:

$$n \cdot \lambda = 2 \cdot d \cdot \sin\vartheta \tag{II}$$

n : diffraction order,
 $d = 282.01$ pm: lattice plane spacing of NaCl

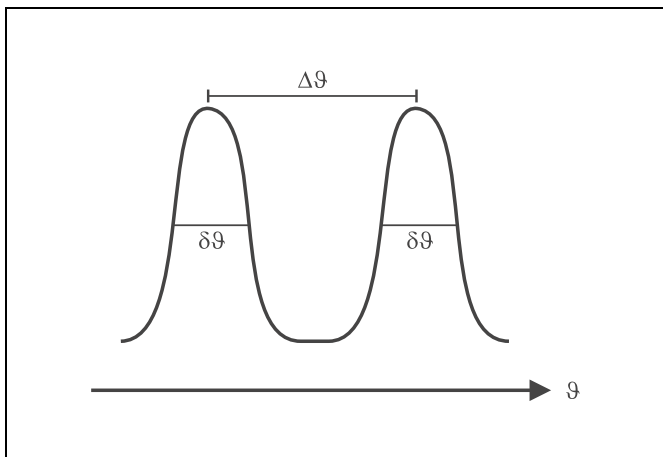

Fig. 2 Definition of the angular width $\delta\vartheta$ and the angular spacing $\Delta\vartheta$ of two intensity maxima.

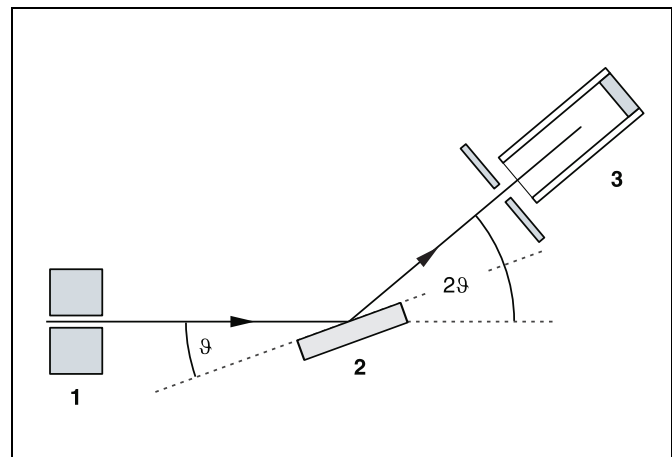

Fig. 3 Diagram showing the diffraction of x-rays at a monocrystal 1 collimator, 2 monocrystal, 3 counter tube

Safety notes

The x-ray apparatus fulfills all regulations governing an x-ray apparatus and fully protected device for instructional use and is type approved for school use in Germany (NW 807/97 Rö).

The built-in protection and screening measures reduce the local dose rate outside of the x-ray apparatus to less than $1 \mu\text{Sv/h}$, a value which is on the order of magnitude of the natural background radiation.

- Before putting the x-ray apparatus into operation inspect it for damage and to make sure that the high voltage is shut off when the sliding doors are opened (see Instruction Sheet for x-ray apparatus).
- Keep the x-ray apparatus secure from access by unauthorized persons.

Do not allow the anode of the x-ray tube Mo to overheat.

- When switching on the x-ray apparatus, check to make sure that the ventilator in the tube chamber is turning.

The goniometer is positioned solely by electric stepper motors.

- Do not block the target arm and sensor arm of the goniometer and do not use force to move them.

The wavelength interval $\Delta\lambda$ of two lines thus corresponds to the angular spacing

$$\Delta\vartheta = \frac{n \cdot \Delta\lambda}{2 \cdot d \cdot \cos\vartheta} \tag{III},$$

which increases with the diffraction order. It is important to distinguish between the angular spacing $\Delta\vartheta$ and the angular width $\delta\vartheta$ of an intensity maximum. This latter should be smaller than the angular spacing so that the two lines can be observed separately (see Fig. 2). The angular width is determined by the opening slit of the counter tube (see Fig. 3), its distance from the crystal and the divergence of the incident x-ray beam, and remains constant even for higher diffraction orders. Thus, the K_{α} doublet can be resolved in the diffraction order $n = 5$.

Setup

Setup in Bragg configuration:

Fig. 4 shows some important details of the experiment setup. To set up the experiment, proceed as follows (see also the Instruction Sheet for the x-ray apparatus):

- Mount the collimator in the collimator mount (a) (note the guide groove).
- Attach the goniometer to guide rods (d) so that the distance s_1 between the slit diaphragm of the collimator and the target arm is approx. 5 cm. Connect ribbon cable (c) for controlling the goniometer.
- Remove the protective cap of the end-window counter, place the end-window counter in sensor seat (e) and connect the counter tube cable to the socket marked GM TUBE.
- By moving the sensor holder (b), set the distance s_2 between the target arm and the slit diaphragm of the sensor seat to approx. 6 cm.

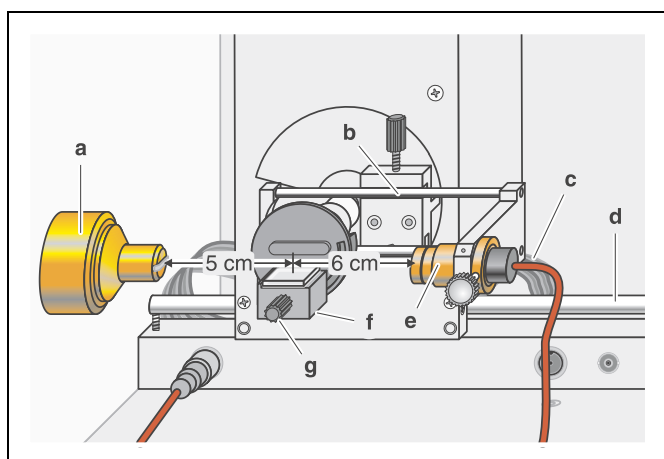

Fig. 4 Experiment setup in Bragg configuration

- Mount the target holder (f) with target stage.
- Loosen knurled screw (g), place the NaCl crystal flat on the target stage, carefully raise the target stage with crystal all the way to the stop and gently tighten the knurled screw (prevent skewing of the crystal by applying a slight pressure).
- If necessary, adjust the mechanical zero position of the goniometer (see Instruction Sheet for x-ray apparatus).

Notes:

NaCl crystals are hygroscopic and extremely fragile. Store the crystals in a dry place; avoid mechanical stresses on the crystal; handle the crystal by the short faces only.

If the counting rate is too low, you can reduce the distance s_2 between the target and the sensor somewhat. However, the distance should not be too small, as otherwise the angular resolution of the goniometer is no longer sufficient.



Preparing the PC-based measurement:

- Connect the RS-232 output and the serial interface on your PC (usually COM1 or COM2) using the 9-pin V.24 cable (supplied with x-ray apparatus).
- If necessary, install the software “X-ray Apparatus” under Windows 9x/NT (see Instruction Sheet for x-ray apparatus) and select the desired language.

Carrying out the experiment

- Start the software “X-ray Apparatus”, check to make sure that the apparatus is connected correctly, and clear any existing measurement data using the button  or the F4 key.
- Set the tube high voltage $U = 35$ kV, the emission current $I = 1.00$ mA and the angular step width $\Delta\beta = 0.1^\circ$.
- Press the COUPLED key for 2 θ coupling of target and sensor.



a) First order of diffraction:

- To record the first diffraction order, set the lower limit of the target angle to 5.5° and the upper limit to 8.0° , and set the measuring time per angular step to $\Delta t = 10$ s.
- Start measurement and data transfer to the PC by pressing the SCAN key.
- When the measurement is finished, open the “Settings” dialog with the button  or F5 and enter the lattice plane spacing for NaCl to show the wavelength-dependency of the counting rate.
- Save the measurement series under a suitable name using the button  or by pressing F2.

b) Fifth order of diffraction:

- To record the fifth diffraction order, set the lower limit of the target angle to 32.5° and the upper limit to 40.5° , and
- Set the measuring time per angular step to $\Delta t = 400$ s.

Note: Due to the low counting rate to be expected, you need to set a relatively long measuring time to obtain a satisfactory statistical accuracy. In this setting, the total measuring time is 9 h.

- Start measurement and data transfer to the PC by pressing the SCAN key.
- When the measurement is finished, open the “Settings” dialog with the button  or F5 and enter the lattice plane spacing for NaCl to show the wavelength-dependency of the counting rate.
- Save the measurement series under a suitable name using the button  or by pressing F2.

Measuring example

Fig. 5 shows the diffraction spectrum measured in the first order, and Fig. 6 shows the spectrum for the fifth order of diffraction.

a) First order of diffraction:

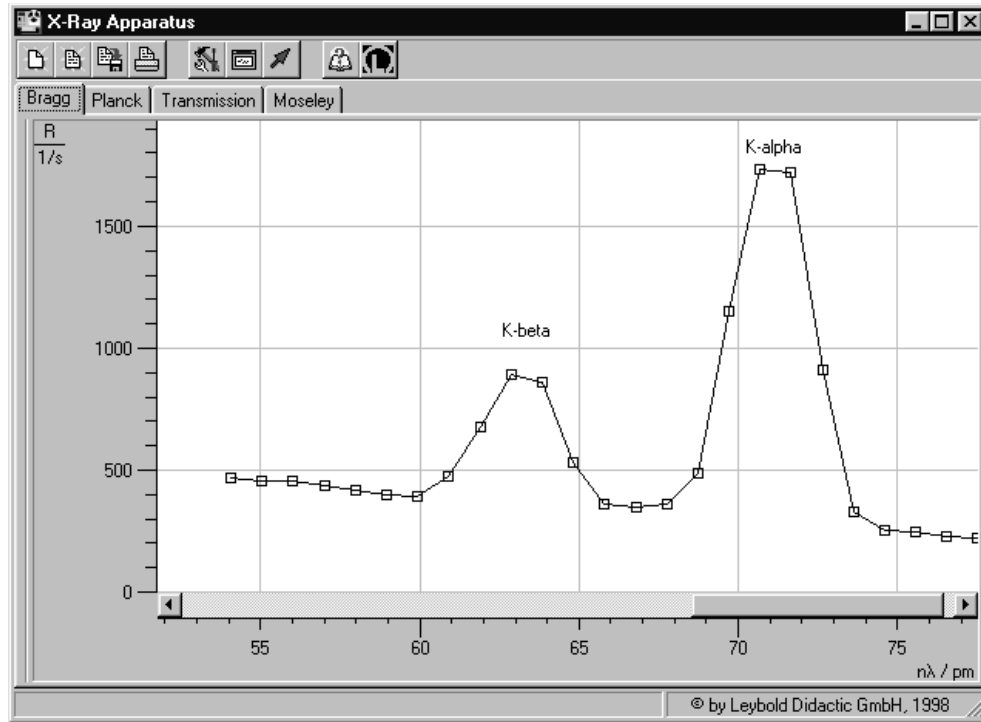

Fig. 5 Diffraction spectrum of x-rays in Bragg reflection in the first order at an NaCl monocrystal
Parameters: $U = 35$ kV,
 $I = 1$ mA, $\Delta t = 10$ s

b) Fifth order of diffraction:

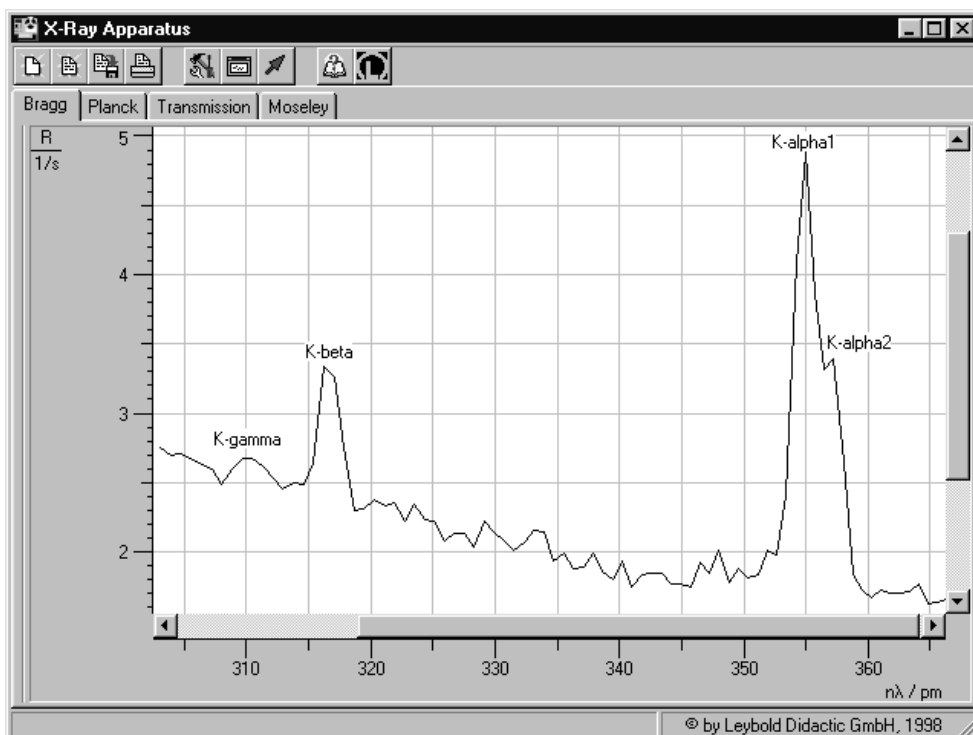

Fig. 6 Diffraction spectrum of x-rays in Bragg reflection in the fifth order at an NaCl monocrystal
Parameters: $U = 35$ kV,
 $I = 1$ mA, $\Delta t = 400$ s

Evaluation

- In the diagram, click the right mouse button to access the evaluation functions of the software "X-ray Apparatus" and select the command "Display Coordinates".
- Drag the mouse pointer across the peaks and read the corresponding $n \cdot \lambda$ values in the bottom left corner of the window.

a) First order of diffraction:

Table 3: Measuring results for the first diffraction order and literature value for the characteristic wavelengths (cf. table 1)

	Measurement result	Literature value
Line doublet	$\frac{\lambda}{\text{pm}}$	$\frac{\lambda}{\text{pm}}$
K_{α}	71.0	71.08
$K_{\beta} + K_{\gamma}$	63.1	63.09

b) Fifth order of diffraction:

Table 4: Measuring results for the fifth diffraction order and literature value for the characteristic wavelengths (cf. tables 1 and 2)

	Measurement result		Literature value
Lines	$\frac{5 \cdot \lambda}{\text{pm}}$	$\frac{\lambda}{\text{pm}}$	$\frac{\lambda}{\text{pm}}$
$K_{\alpha 1}$	355	71.0	70.93
$K_{\alpha 2}$	357	71.4	71.36
K_{β}	316.7	63.34	63.26
K_{γ}	310.3	62.06	62.09

Splitting of doublet K_{α} :

$\Delta\lambda = 0.4 \text{ pm}$ Literature value: $\Delta\lambda = 0.43 \text{ pm}$

Splitting of doublet $K_{\beta} + K_{\gamma}$:

$\Delta\lambda = 1.28 \text{ pm}$ Literature value: $\Delta\lambda = 1.17 \text{ pm}$

Results

The characteristic K_{α} and K_{β} lines we observe in the first diffraction order split into doublets. We can observe this split in the fifth diffraction order.

The fine structure of the K_{α} doublet is a consequence of the fine structure of the L-shell. The K_{β} doublet is composed of the pure K_{β} line and the K_{γ} line.

Additional information

Strictly speaking, the K_{β} and K_{γ} lines also show a fine structure due to the fine structure of shells M and N. However, this split is so slight that we cannot observe it with the means at hand. Table 1 shows the weighted mean values of the respective individual lines from this substructure.

Literature

- [1] C. M. Lederer and V. S. Shirley, Table of Isotopes, 7th Edition, 1978, John Wiley & Sons, Inc., New York, USA.

